

Touch Side View

JL1 & JL2		JL3(USB)	
PIN#	Assignment	PIN#	Assignment
1-2	GND	1	USB_5V
3	NC	2	D-
4	GND	3	D+
5-39	X1-X35	4	GND
40	GND	JL4(I2C/UART)	
41-51	NC	PIN#	Assignment
52	GND	1	VCC
53	NC	2	GND
54-75	Y1-Y22	3	SCL/RXD
76-77	NC	4	SDA/TXD
78	GND	5	nRESET
79	NC	6	nDETECT
80	GND	7	nINT

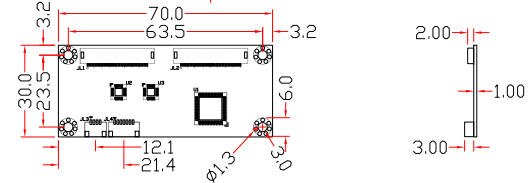

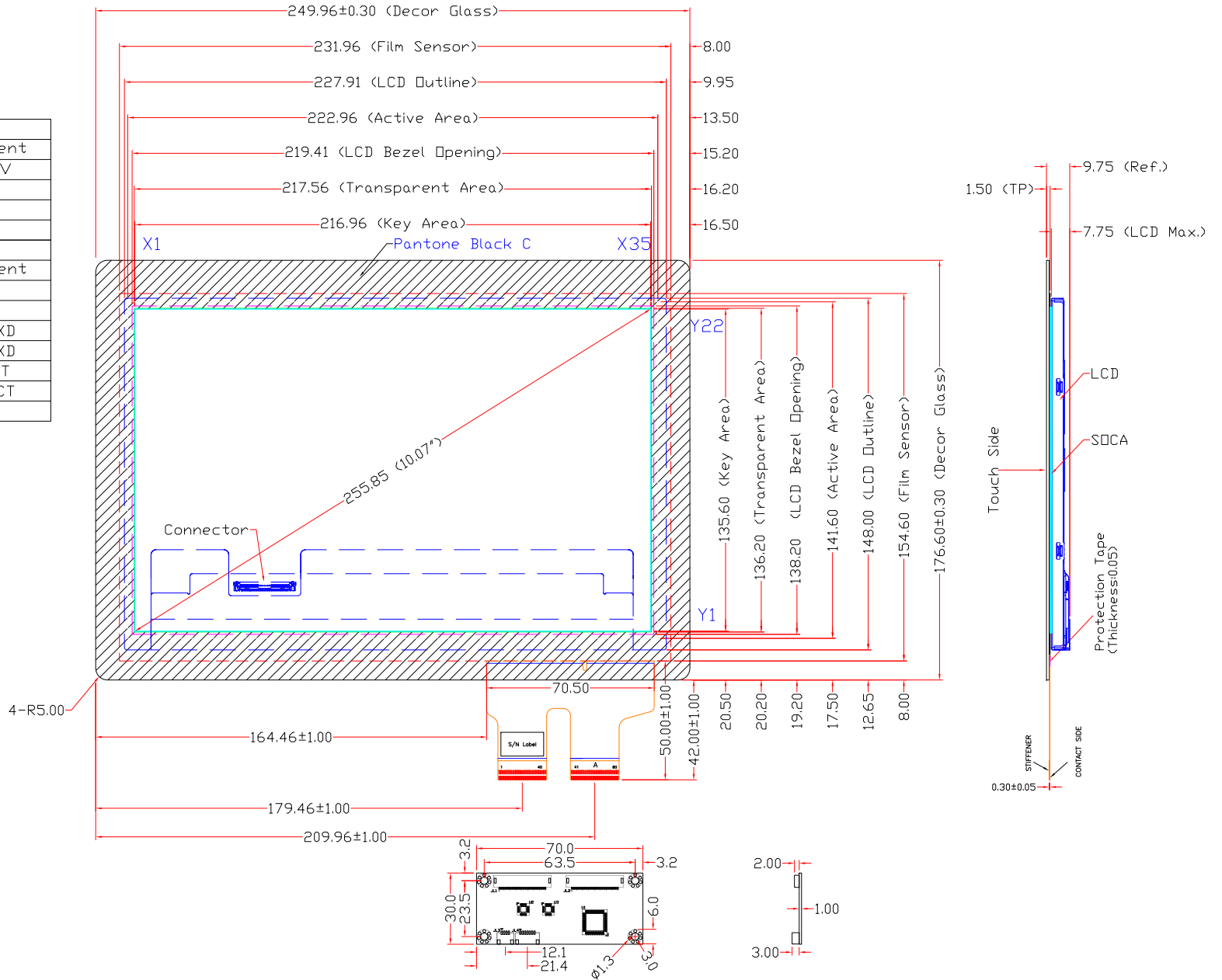

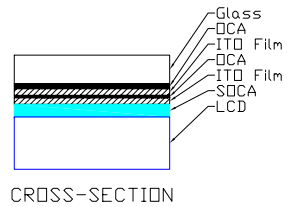
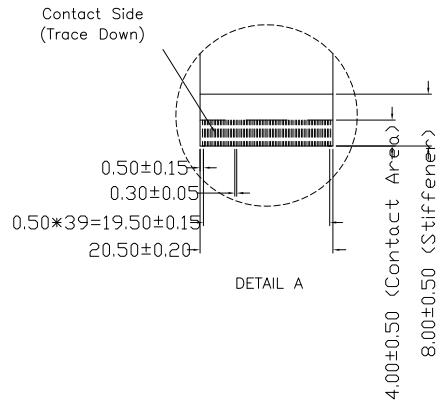

- NOTES:
1. OVERALL THICKNESS : 9.75mm (FOR REFERENCE ONLY)
 2. TOUCH PANEL : 92-P3021-AGA-F01
 3. LCD : AUO G101EAN02.2
 4. PROCESS : DRY BONDING
 5. OTHER SPEC : SEE APPROVAL SHEET

AMT Apex Material Technology Corp.				RoHS COMPLIANT
NO.	DESCRIPTION	CHK	TOLERANCES UNLESS SPECIFIED	
REVISION			.X	± 0.50
CHIEF OF DESIGN	APPROVED	Only	.XX	± 0.50
DRAWN BY	Leo	DATE	2022.10.24	.XXX
SHEET 1 OF 2			SCALE	1:1

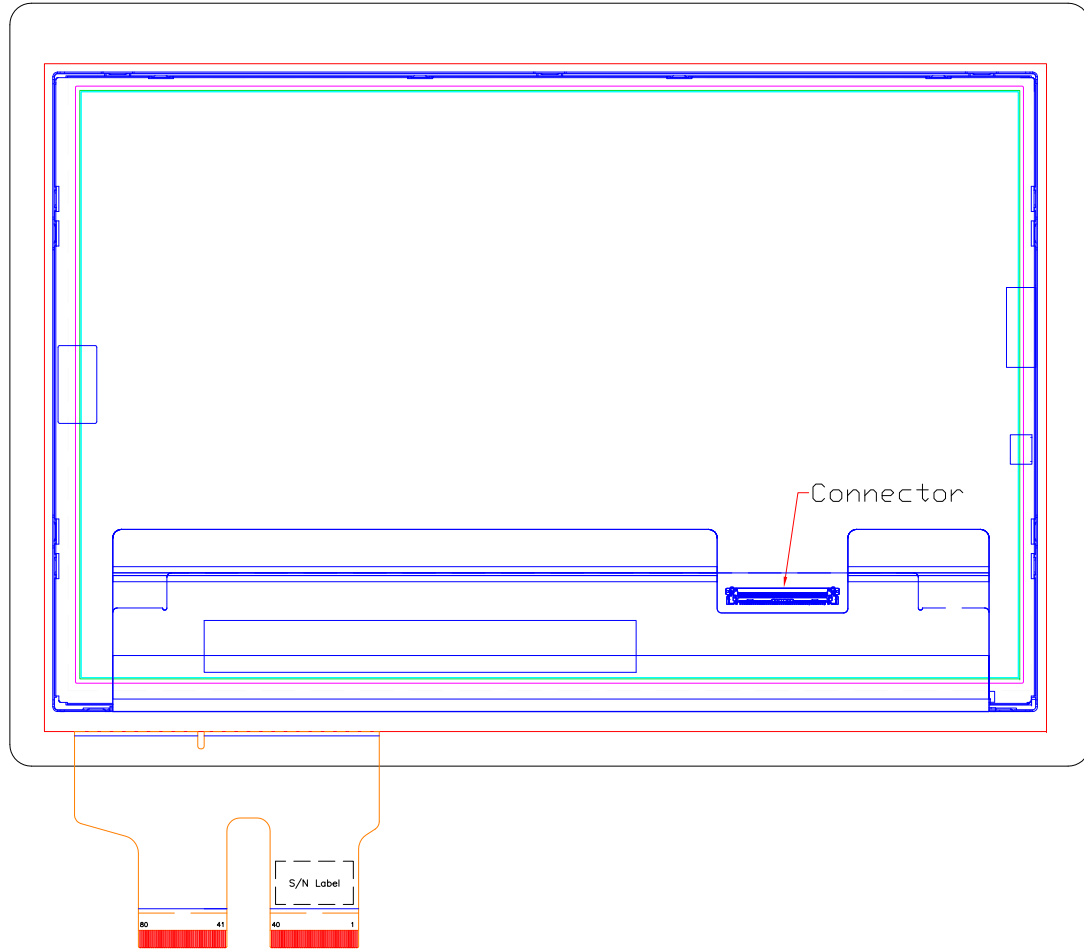
DWG NO: AD-96-T1010-000-A01-01

Rear Side View



 Apex Material Technology Corp.				DWG NO:	
				AD-96-T1010-000-A01-01	
NO.	DESCRIPTION	CHK	TOLERANCES UNLESS SPECIFIED		
REVISION			.X	± 0.50	
CHIEF OF DESIGN	APPROVED	Only	.XX	± 0.50	
DRAWN BY	DATE	2022.10.24	.XXX	± 0.30	
SHEET 2 OF 2			SCALE	1:1	