

Part Number:
96-T2150-000-B01

TOUCH SIDE VIEW

PIN#	Assignment(JL1)
1	GND
2	NC
3-77	X75-X1
78	NC
79-80	GND

JL3(USB)	
PIN#	DESIGNATION
1	USB_5V
2	D-
3	D+
4	GND

PIN#	Assignment(JL2)
1	GND
2-5	NC
6-48	Y43-Y1
49	NC
50	GND

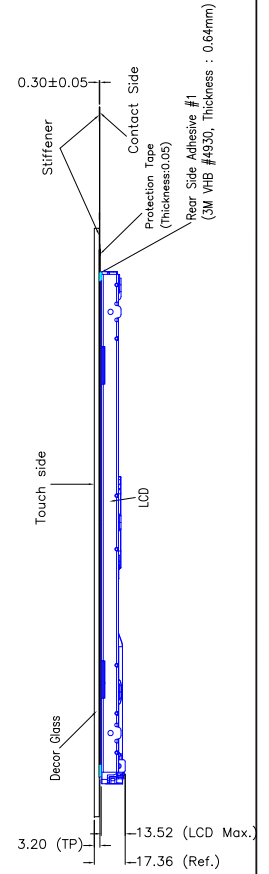
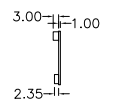
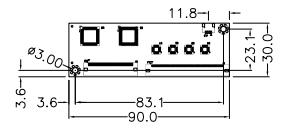
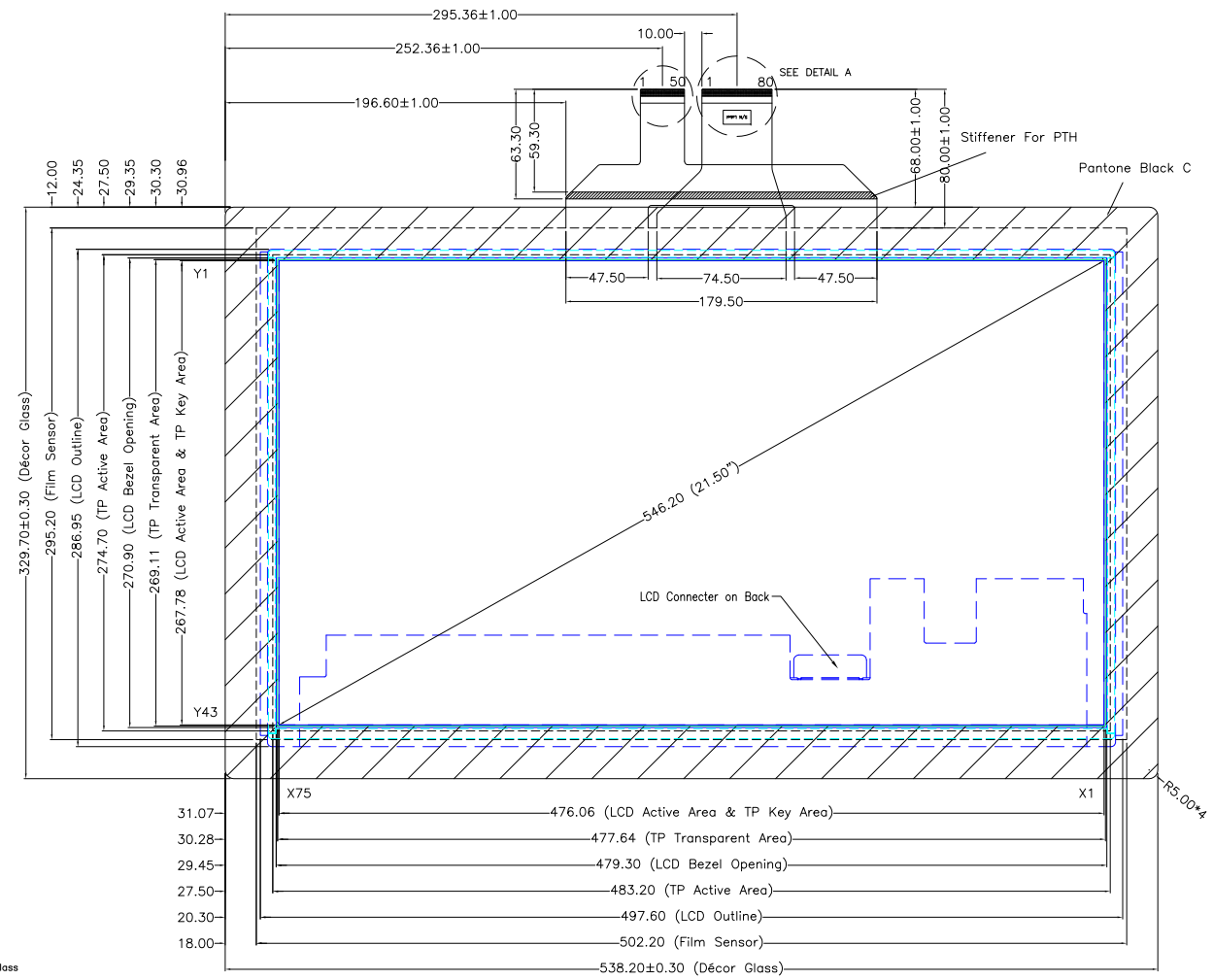
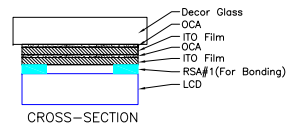
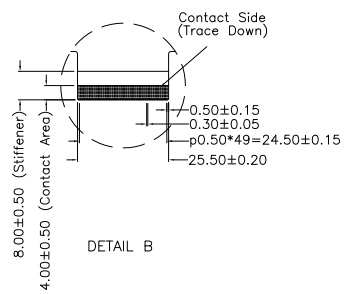
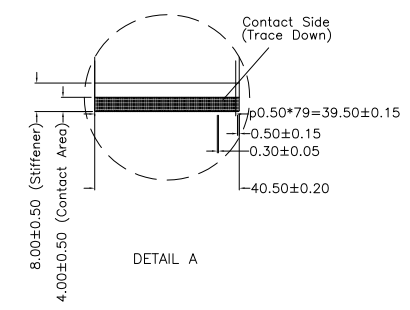

- NOTES:
- OVERALL THICKNESS : 17.36mm(REFERENCE ONLY)
 - LCD : INNOLUX G215HCJ-L01
 - TOUCH PANEL : 92-P3022-AGE-F02
 - REAR SIDE ADHESIVE #1 : 3M VHB #4930(THICKNESS : 0.64mm)
 - PROCESS : AIR BONDING
 - OTHER SPEC : SEE APPROVAL SHEET



NO.	DATE	DESCRIPTION	CHK
REVISION			
CHEF OF DESIGN		APPROVED	Only
DRAWN BY	Jackson	DATE	2022.11.02
SHEET 1 OF 2			

Apex Material Technology Corp.

TOLERANCES UNLESS SPECIFIED		DWG NO :
.X	± 0.50	AD-96-T2150-000-B01-013
.XX	± 0.50	
.XXX	± 0.30	
ANGULAR	.	SCALE: N/S UNIT: mm

Part Number:
96-T2150-000-B01

REAR SIDE VIEW

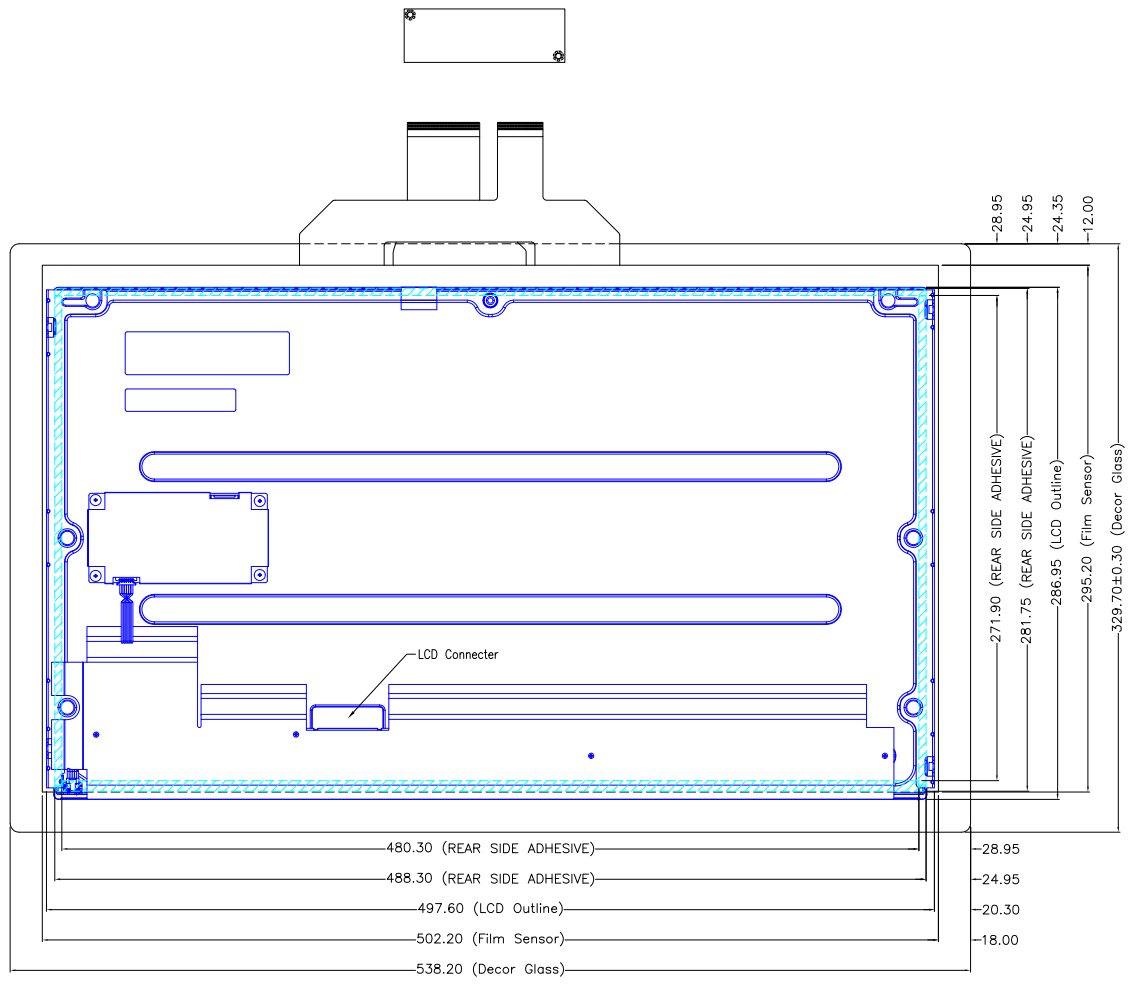

Apex Material Technology Corp.

NO.	DATE	DESCRIPTION	CHK	TOLERANCES UNLESS SPECIFIED		DWG NO : AD-96-T2150-000-B01-013
REVISION				.X	± 0.50	
CHIEF OF DESIGN		APPROVED	Orly	.XX	± 0.50	
DRAWN BY	Jackson	DATE	2022.11.02	.XXX	± 0.30	
SHEET 2 OF 2				ANGULAR	.	

